

# DS-KD8003-IME2/NS

## Video Intercom Module Door Station

**HIKVISION**



### Key Feature

- Two-pin wire for power supply and network access
- Access control function
- Noise suppression and echo cancellation
- H.264 video compression
- Low illumination
- Tampering alarm
- Fisheye camera with IR supplement light
- Supports sub-modules' access (max. 8)
- Nametag customization
- Easy to and extend

### Typical Application

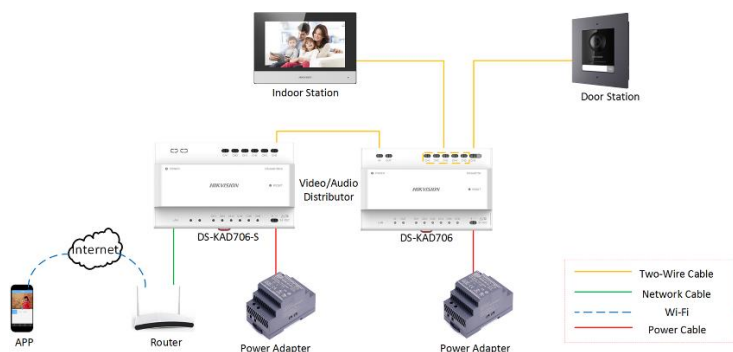

	c. EN 61000-3-3:2013 d. EN 50130-4:2011 +A1:2014
CE-LVD	EN 60950-1:2006 + A11:2009 + A1:2010 + A12:2011 + A2:2013
CB	IEC 60950-1:2005 (Second Edition) + Am 1:2009 + Am 2:2013
FCC-SDOC	47 CFR Part 15, Subpart B
C-TICK(EMC)	AS/NZS CISPR 32:2015
UL	UL 60950-1 & CAN/CSA C22.2 No. 60950-1-07, Information Technology Equipment – Safety – Part 1: General Requirements
ROHS	2011/65/EU
REACH	Regulation (EC) No 1907/2006
WEEE	2012/19/EU

### Approval

CE-EMC	a. EN 55032:2015 b. EN 61000-3-2:2014
--------	--

## Specification

System parameters	
Processor	Embedded MCU Processor
Operation system	Embedded Linux operation system
Operation method	Physical button
Video Parameters	
Camera	Low illumination 2 MP HD IR camera
Video Compression Standard	H.264
Resolution	Main stream : 1920 × 1080 Sub stream : 720 × 480
Video stream	Main stream: 1080p@30fps, 720p@30fps (configurable); sub stream: D1
BLC	Supported
DNR	Supported
WDR	Supported
Anti-flicker	50 Hz, 60 Hz
Field of view	Horizontal: 180° Vertical: 96°
Motion detection	Supported
Audio parameters	
Audio intercom	Full-duplex two-way audio intercom
Audio input	Built-in omnidirectional microphone
Audio output	Built-in loudspeaker (More than 85 dB within 20 cm)
Audio compression standard	G.711 U
Audio compression Rate	64 Kbps
Audio quality	Noise suppression and echo cancellation
Light supplement	
Light supplement mode	IR supplement
Network parameters	
Wired network interface	Two-wire transmission
Network protocol	TCP/IP, RSTP
Access control	
Relay interface (main module)	2, NO + NC separately draw forth
Interfaces	
Module-connecting	1
Tampering alarm	1
Alarm input	4
Performances	
Card capacity	Max. 10000
User capacity	Max. 2000
Linked Indoor station	Max. 100

Linked sub door station	Max. 8
Linked doorphone	Max. 8
Protocol	ISAPI, RTSP, STMP, SNMP
Unlock door	Unlock by presenting cards, unlock via Client Software, unlock via App, unlock via indoor station

General	
Protection level	IP 65
Power consumption	4 W
Power input	24 VDC two-wire power supply (< 16 W) or 12 VDC independent power supply (< 20 W)
Power output	12 VDC (only for power supply of submodule)
Working temperature	-40° C to +60° C (-40° F to 140° F)
Working humidity	10% to 95%
Installation	Flush mounting, surface mounting
Dimension	98 mm × 99.8 mm × 43.9 mm (3.86" × 3.93" × 1.73")
Material	Stainless steel

## Available Model

DS-KD8003-IME2/NS

## Appearance and Interfaces

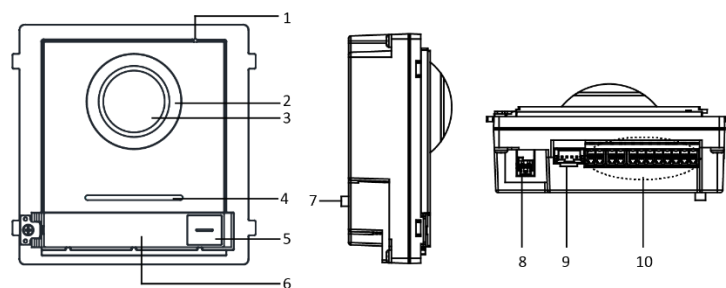

No.	Description	No.	Description
1	Microphone	6	Nametag
2	Low Illumination IR Supplement Light	7	TAMPER
3	Built-in Camera	8	Network Interface and Power Supply
4	Loudspeaker	9	Module-connecting Interface (output)
5	Call Button	10	Terminals

**Dimension**

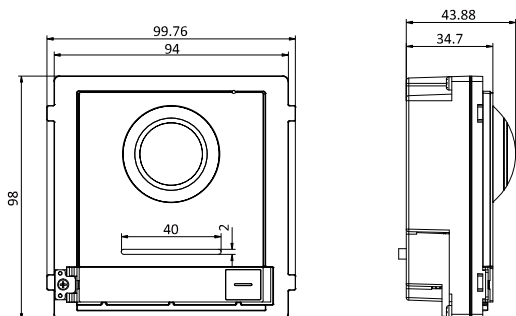

**Accessory**

**Optional**



DS-KD-ACF1/Plastic

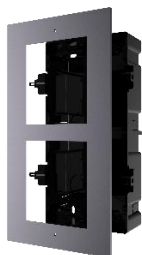

DS-KD-ACF2/Plastic

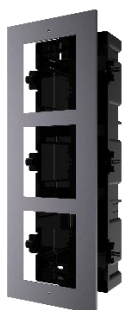

DS-KD-ACF3/Plastic

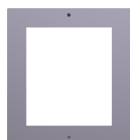

DS-KD-ACW1



DS-KD-ACW2



DS-KD-ACW3



DS-KD-ACF1/S



DS-KD-ACF2/S



DS-KD-ACF3/S



DS-KD-ACW1/S

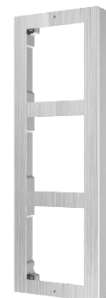

DS-KD-ACW2/S

DS-KD-ACW3/S

