

DS-KD8003-IME1/NS

Video Intercom Module Door Station

HIKVISION



Key Feature

- 2 MP HD video intercom function
- Access control function
- Noise suppression and echo cancellation
- Low illumination
- Tampering alarm supported
- Fisheye camera with IR supplement light
- Supports sub-modules' access (max. 7)
- Nametag customization
- Easy to and extend

Approval

CE-EMC	a. EN 55032:2015 b. EN 61000-3-2:2014 c. EN 61000-3-3:2013 d. EN 50130-4:2011 +A1:2014
CE-LVD	EN 60950-1:2006 + A11:2009 + A1:2010 + A12:2011 + A2:2013
CB	IEC 60950-1:2005 (Second Edition) + Am 1:2009 + Am 2:2013
FCC-SDOC	47 CFR Part 15, Subpart B
C-TICK(EMC)	AS/NZS CISPR 32:2015
UL	UL 60950-1 & CAN/CSA C22.2 No. 60950-1-07, Information Technology Equipment – Safety – Part 1: General Requirements
ROHS	2011/65/EU
REACH	Regulation (EC) No 1907/2006
WEEE	2012/19/EU

Typical Application

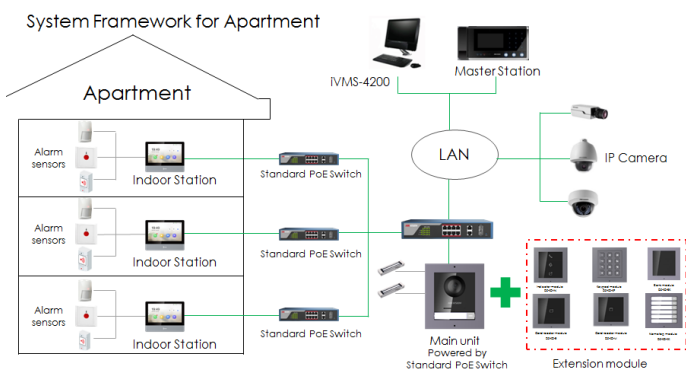

Specification

System parameters	
Processor	Embedded MCU Processor
Operation system	Embedded Linux operation system
Operation method	Physical button
Video Parameters	
Camera	Low illumination 2 MP HD IR camera
Video Compression Standard	H.264
Resolution	Main stream : 1920 × 1080 Sub stream : 720 × 480
BLC	Supported
DNR	Supported
WDR	Supported
Anti-flicker	50 Hz, 60 Hz
Field of view	Horizontal: 180° Vertical: 96°
Audio parameters	
Audio input	Built-in omnidirectional microphone
Audio output	Built-in loudspeaker (More than 85 dB within 20 cm)
Audio compression standard	G.711 U
Audio compression Rate	64 Kbps
Audio quality	Noise suppression and echo cancellation
Light supplement	
Light supplement mode	IR supplement
Network parameters	
Ethernet	10/100 Mbps self-adaptive Ethernet
Network protocol	TCP/IP, RSTP
Alarm parameters	
Tampering alarm	1
Interfaces	
Module-connecting	1
Door contact input	2
Exit button input	2
I/O input	4
Debug	1
Door control	2, breakdown voltage: 36 V
Performances	
Card capacity	Max. 10000
User capacity	Max. 2000
Linked Indoor station	Max. 100
Linked sub door station	Max. 8

Linked doorphone	Max. 8
Protocol	ISAPI, RTSP, STMP, SNMP
Unlock door	Unlock by presenting cards, unlock via Client Software, unlock via App, unlock via indoor station
General	
Power supply	12 VDC/PoE (IEEE 802.3af)
Power consumption	4 W
Working temperature	-40° C to +55° C (-40° F to 131° F)
Working humidity	10% to 95%
Installation	Flush mounting, surface mounting
Dimension	98 mm × 99.8 mm × 43.9 mm (3.86" × 3.93" × 1.73")
Material	Stainless steel

Available Model

DS-KD8003-IME1/NS

Appearance and Interfaces

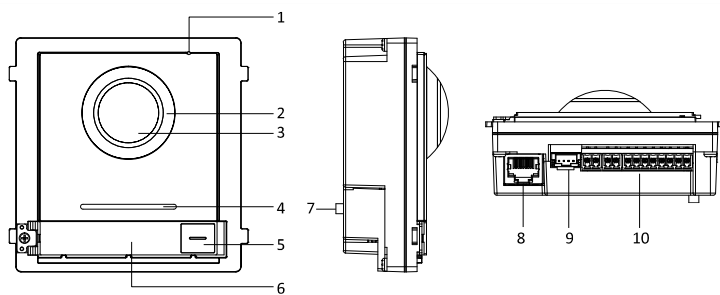

No.	Description	No.	Description
1	Microphone	6	Nametag
2	Low Illumination IR Supplement Light	7	TAMPER
3	Built-in Camera	8	Network Interface
4	Loudspeaker	9	Module-connecting Interface (output)
5	Call Button	10	Terminals

Dimension

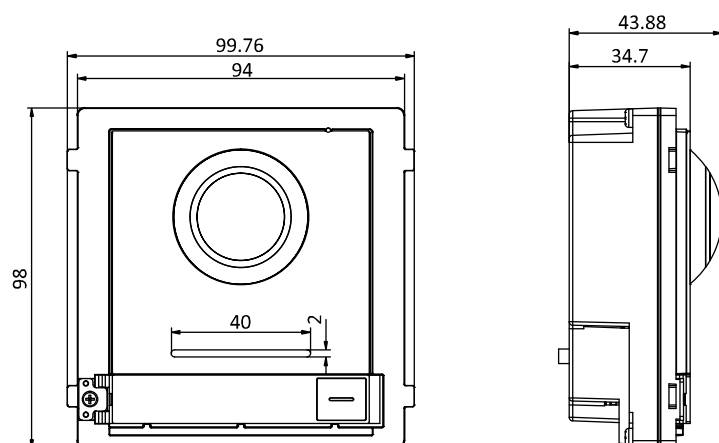

Accessory

Optional



DS-KD-ACF1/Plastic

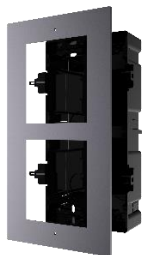

DS-KD-ACF2/Plastic

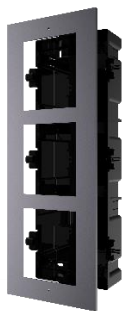

DS-KD-ACF3/Plastic

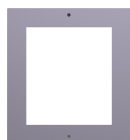

DS-KD-ACW1



DS-KD-ACW2



DS-KD-ACW3



DS-KD-ACF1/S

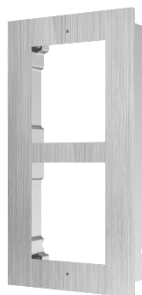

DS-KD-ACF2/S



DS-KD-ACF3/S



DS-KD-ACW1/S



DS-KD-ACW2/S

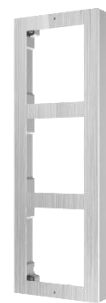

DS-KD-ACW3/S

